

s18741

ENVOYÉ PAR
ADMIN Servisco
magicplan@servisco.be

CRÉÉ LE
2023-09-08

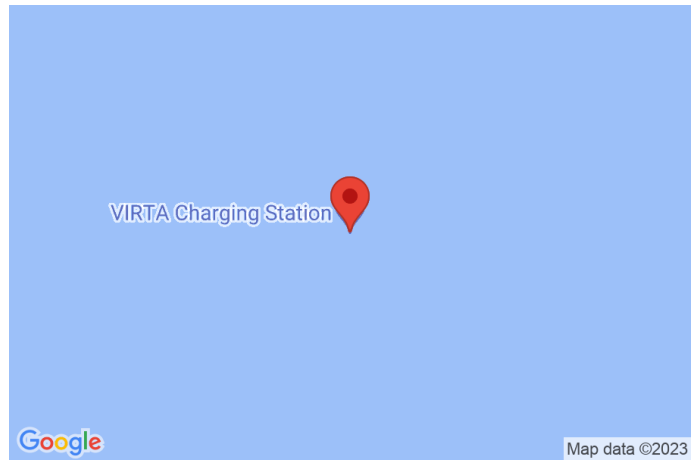

Surface totale 108.14 m ²	Étages 1	Pièces 8	Salle de bain 1
--	--------------------	--------------------	---------------------------

▼ Rez-de-chaussée

SURFACE TOTALE : 108.14 m² • SURFACE HABITABLE : 49.39 m² • PIÈCES : 8

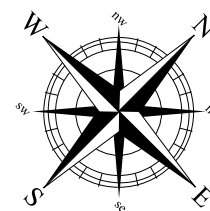
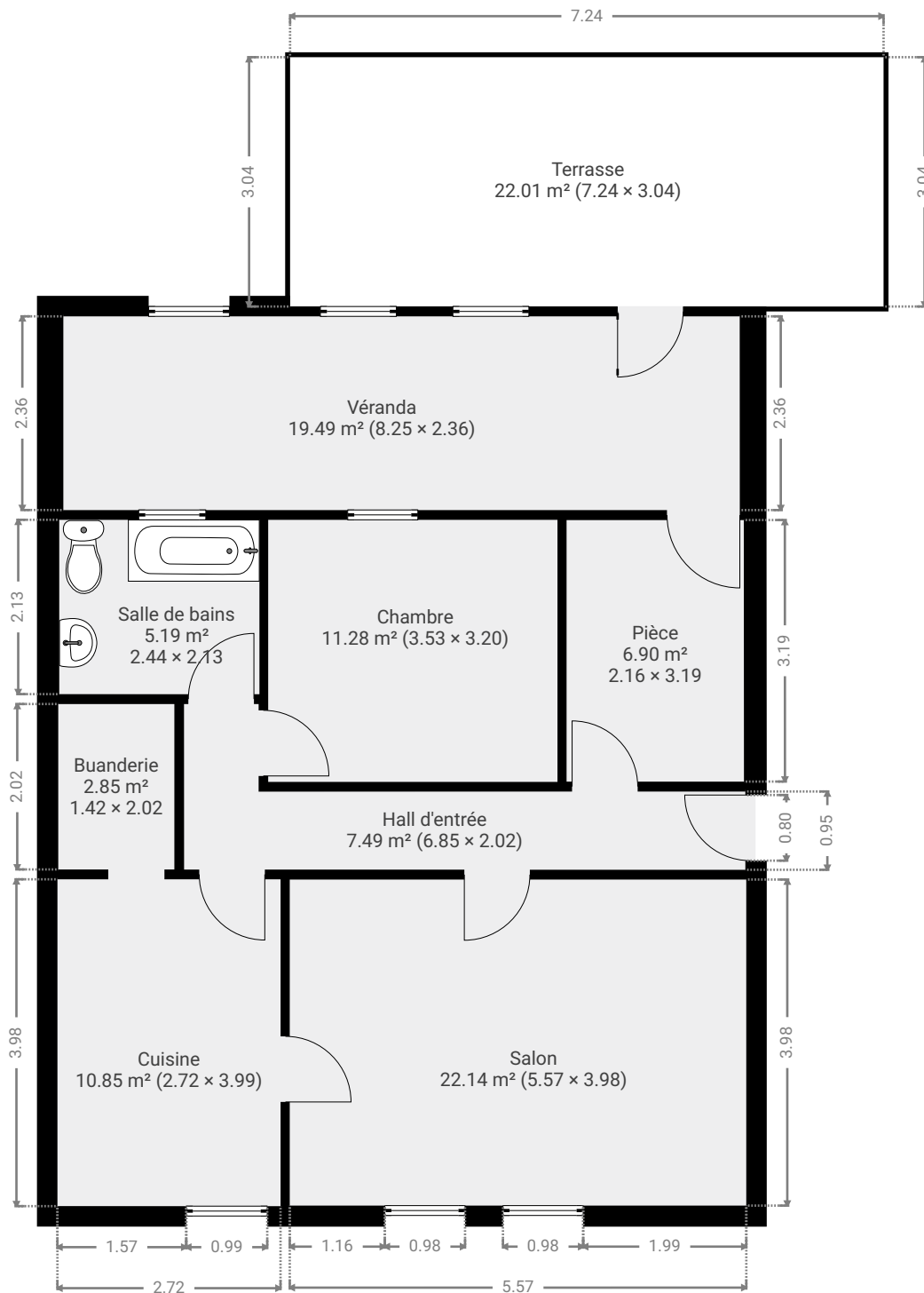

▼ **Buanderie**
Rez-de-chaussée

LARGEUR : 1.42 m • LONGUEUR : 2.02 m
SURFACE : 2.85 m² • PÉRIMÈTRE : 6.86 m

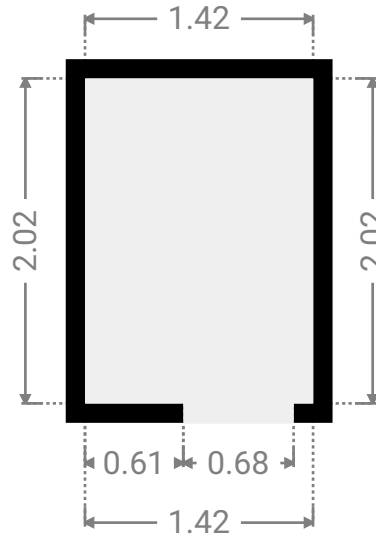
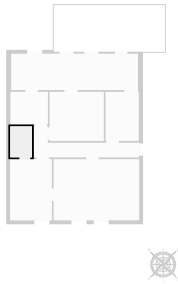

▼ **Chambre**
Rez-de-chaussée

LARGEUR : 3.53 m • LONGUEUR : 3.20 m
SURFACE : 11.28 m² • PÉRIMÈTRE : 13.45 m

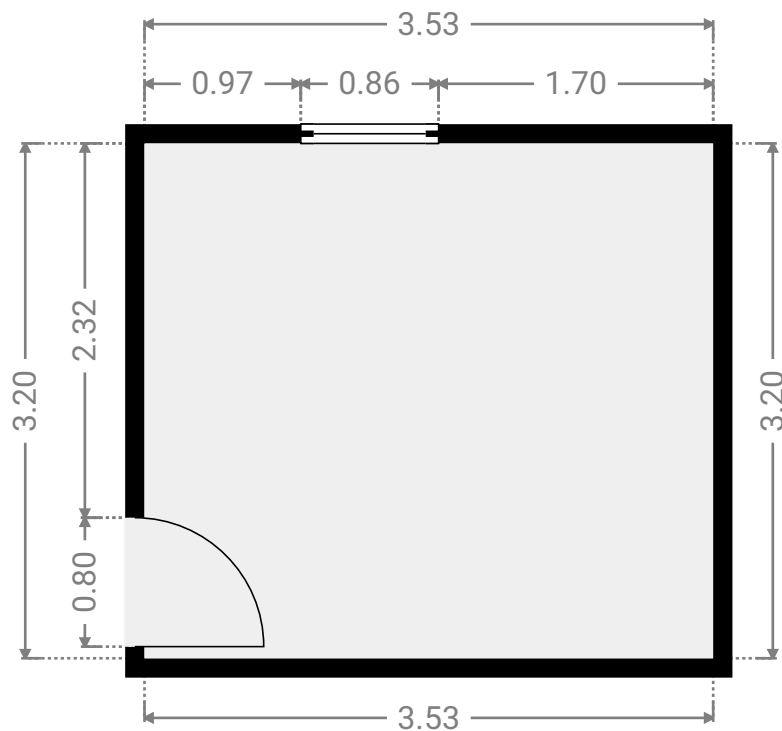
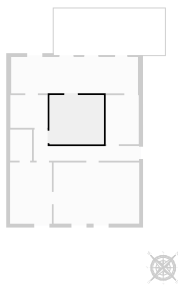

▼ **Cuisine**
Rez-de-chaussée

LARGEUR : 2.72 m • LONGUEUR : 3.99 m
SURFACE : 10.85 m² • PÉRIMÈTRE : 13.41 m

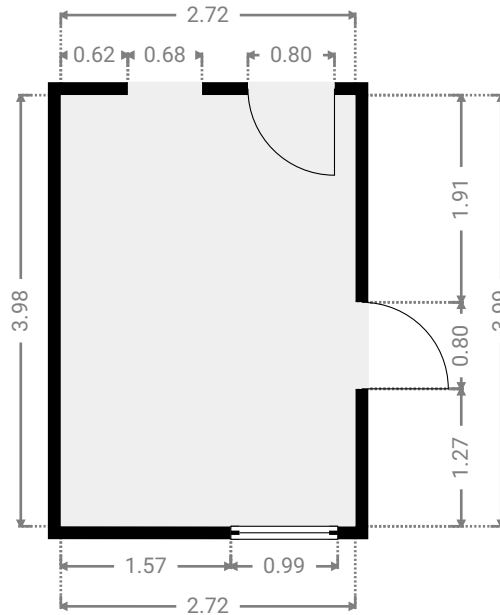
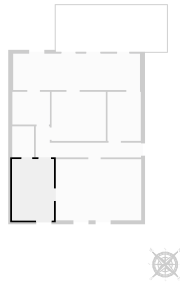

▼ **Hall d'entrée**
Rez-de-chaussée

LARGEUR : 6.85 m • LONGUEUR : 2.02 m
SURFACE : 7.49 m² • PÉRIMÈTRE : 17.74 m

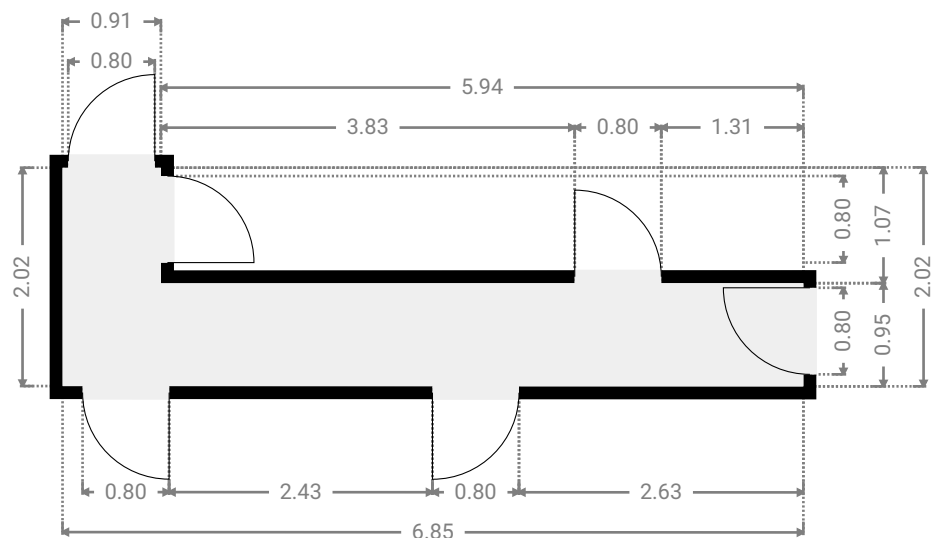
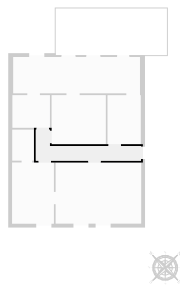

▼ **Pièce**
Rez-de-chaussée

LARGEUR : 2.16 m • LONGUEUR : 3.19 m
SURFACE : 6.90 m² • PÉRIMÈTRE : 10.70 m

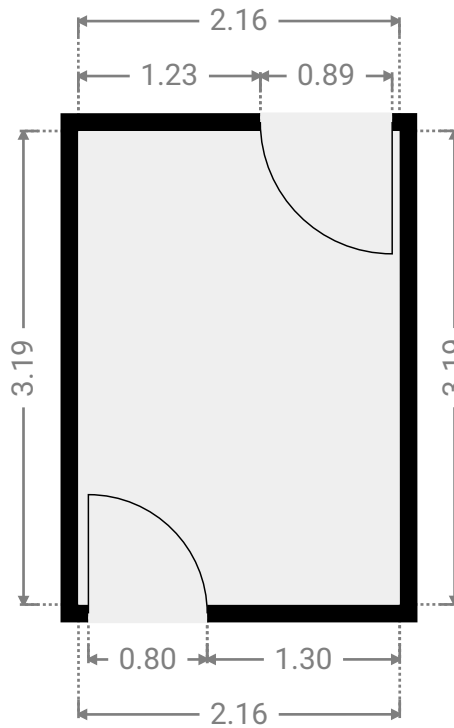
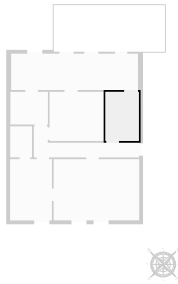

▼ **Salle de bains**
Rez-de-chaussée

LARGEUR : 2.44 m • LONGUEUR : 2.13 m
SURFACE : 5.19 m² • PÉRIMÈTRE : 9.13 m

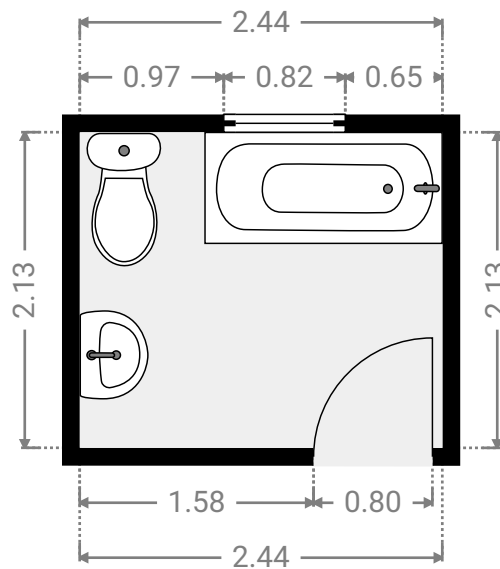
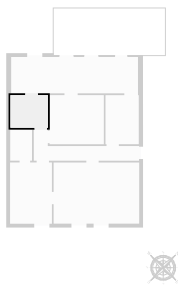

▼ **Salon**
Rez-de-chaussée

LARGEUR : 5.57 m • LONGUEUR : 3.98 m
SURFACE : 22.14 m² • PÉRIMÈTRE : 19.09 m

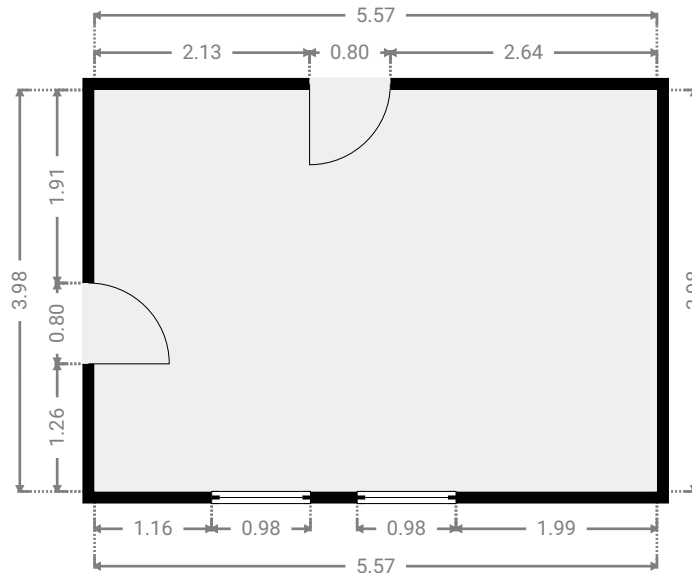
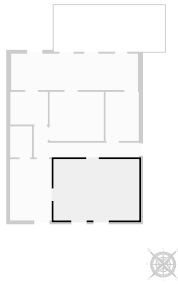

▼ **Véranda**
Rez-de-chaussée

LARGEUR : 8.25 m • LONGUEUR : 2.36 m
SURFACE : 19.49 m² • PÉRIMÈTRE : 21.23 m

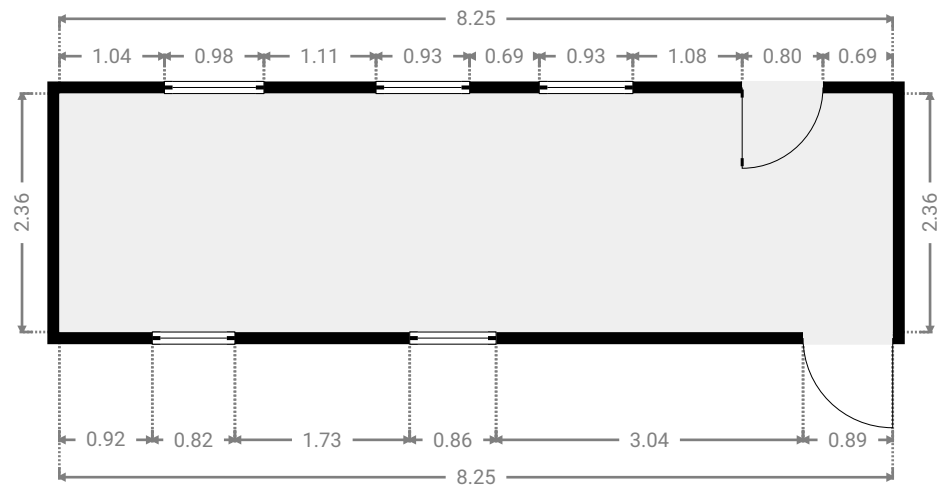
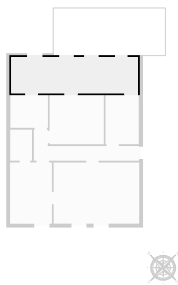

▼ **Terrasse**
Rez-de-chaussée

LARGEUR : 7.24 m • LONGUEUR : 3.04 m
SURFACE : 22.01 m² • PÉRIMÈTRE : 20.56 m

