

























Elektriciteit

-  Enkelpolige schakelaar
-  Dubbelpolige schakelaar
-  Dubbele richting schakelaar
-  Enkel stopcontact
-  Elektrische aansluiting
-  Thermostaat
-  bewegings sensor
-  Lichtpunt
-  Wandlichtpunt
-  Tv distributie
-  Telefoonaansluiting
-  UTP-aansluiting
-  Elektrisch bord
-  Wasmachine
-  Droogkast
-  CV-ketel
-  enkel trekdraad
-  LS
-  CLS
-  rookmelder
-  Videofoon
-  Radiator

Technische wanddeling berging

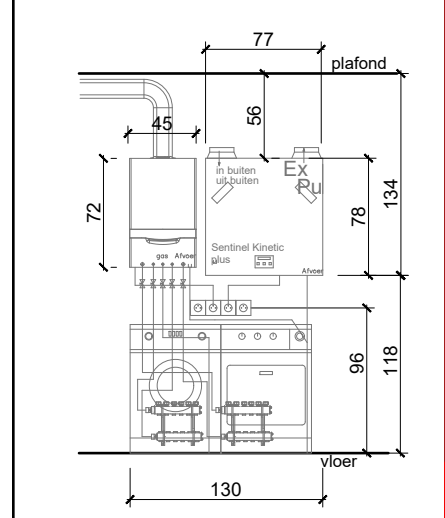

Indeling + technieken volgens leidschema leverancier keuken

NOTA
 Deze tekening vervangt alle voorgaande tekeningen
 Vals plafond
 Inplanting keuken en sanitaire toestellen zie detailplan leverancier + positionering van het bijhorende leidingnet.
 Alle stopcontacten op hoogte 0,30m tov. pas 0.00
 Alle schakelaars op hoogte 1,10m tov. pas 0.00
 Thermostaat + videofoon op hoogte 1,65m tov. pas 0.00